

Installation and Operating Guide | Warranty

Model Number | DTT901 | Digital TV Tuner Converter Box
With Analog Pass-Through

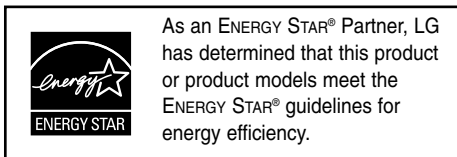

As an ENERGY STAR® Partner, LG has determined that this product or product models meet the ENERGY STAR® guidelines for energy efficiency.

ENERGY STAR® is a U.S. registered mark.



For service/
support Call:
Toll Free Number

1-877-9-ZENITH

(<http://www.zenithservice.com>)

DTV
TUNER



© Copyright 2007, LG Electronics U.S.A., Inc.



CAUTION

RISK OF ELECTRIC SHOCK
DO NOT OPEN



CAUTION: TO REDUCE THE RISK OF ELECTRIC SHOCK DO NOT REMOVE COVER (OR BACK) NO USER-SERVICEABLE PARTS INSIDE REFER SERVICING TO QUALIFIED SERVICE PERSONNEL.



This lightning flash with arrowhead symbol within an equilateral triangle is intended to alert the user to the presence of uninsulated dangerous voltage within the product's enclosure that may be of sufficient magnitude to constitute a risk of electric shock to persons.



The exclamation point within an equilateral triangle is intended to alert the user to the presence of important operating and maintenance (servicing) instructions in the literature accompanying the product.

WARNING: TO PREVENT FIRE OR ELECTRIC SHOCK HAZARD, DO NOT EXPOSE THIS PRODUCT TO RAIN OR MOISTURE.

WARNING: Do not install this equipment in a confined space such as a bookcase or similar unit.

CAUTION: Do not block any ventilation openings. Install in accordance with the manufacturer's instructions.

Slots and openings in the cabinet are provided for ventilation and to ensure reliable operation of the product and to protect it from overheating.

The openings should be never be blocked by placing the product on a bed, sofa, rug or other similar surface. This product should not be placed in a built-in installation such as a bookcase or rack unless proper ventilation is provided or the manufacturer's instruction have been adhered to.

CAUTION: The apparatus should not be exposed to water (dripping or splashing) and no objects filled with liquids, such as vases, should be placed on the apparatus.

CAUTION concerning the Power Cord

Most appliances recommend they be placed upon a dedicated circuit;

That is, a single outlet circuit which powers only that appliance and has no additional outlets or branch circuits.

Check the specification page of this owner's manual to be certain.

Do not overload wall outlets. Overloaded wall outlets, loose or damaged wall outlets, extension cords, frayed power cords, or damaged or cracked wire insulation are dangerous. Any of these conditions could result in electric shock or fire. Periodically examine the cord of your appliance, and if its appearance indicates damage or deterioration, unplug it, discontinue use of the appliance, and have the cord replaced with an exact replacement part by an authorized servicer.

Protect the power cord from physical or mechanical abuse, such as being twisted, kinked, pinched, closed in a door, or walked upon. Pay particular attention to plugs, wall outlets, and the point where the cord exits the appliance.

To disconnect power from the unit, pull out the units power cord from the outlet. When installing the product, ensure that the plug is easily accessible.

FCC WARNING: This equipment may generate or use radio frequency energy. Changes or modifications to this equipment may cause harmful interference unless the modifications are expressly approved in the instruction manual. The user could lose the authority to operate this equipment if an unauthorized change or modification is made.

REGULATORY INFORMATION: FCC Part 15

This equipment has been tested and found to comply with the limits for a Class B digital device, pursuant to Part 15 of the FCC Rules. These limits are designed to provide reasonable protection against harmful interference when the product is operated in a residential installation. This product generates, uses, and can radiate radio frequency energy and, if not installed and used in accordance with the instruction manual, may cause harmful interference to radio communications. However, there is no guarantee that interference will not occur in a particular installation. If this product does cause harmful interference to radio or television reception, which can be determined by turning the product off and on, the user is encouraged to try to correct the interference by one or more of the following measures:

- Reorient or relocate the receiving antenna.
- Increase the separation between the product and receiver.
- Connect the product into an outlet on a circuit different from that to which the receiver is connected.
- Consult the dealer or an experienced radio/TV technician for help.

CAUTION:

DO NOT ATTEMPT TO MODIFY THIS PRODUCT IN ANY WAY WITHOUT WRITTEN AUTHORIZATION FROM LG ELECTRONICS CORPORATION.

UNAUTHORIZED MODIFICATION COULD VOID THE USER'S AUTHORITY TO OPERATE THIS PRODUCT. THIS EQUIPMENT IS INTENDED TO RECEIVE AND DECODE SIGNALS TRANSMITTED ACCORDING TO ATSC DIGITAL TELEVISION STANDARD A/53, SPECIFICATION AND IS INTENDED TO BE USED WITH AN APPROPRIATE ANTENNA AND DISPLAY DEVICE THAT YOU MUST PROVIDE.

FCC COMPLIANCE: The responsible party for this product's compliance is:

Marketed and Distributed by LG Electronics U.S.A., Inc.,
1000 Sylvan Avenue, Englewood Cliffs, NJ.
Phone: 1-201-816-2000.

Zenith-brand consumer electronics products are marketed by LG Electronics USA, Inc.

IMPORTANT SAFETY INSTRUCTIONS

Please read and observe all warnings and instructions in this owner's manual. And those marked on the product. Retain this booklet for future reference.

PLEASE READ AND OBSERVE ALL WARNINGS AND INSTRUCTIONS IN THIS OWNER'S MANUAL. AND THOSE MARKED ON THE PRODUCT. RETAIN THIS BOOKLET FOR FUTURE REFERENCE.

1. Read these instructions.
2. Keep these instructions.
3. Heed all warnings.
4. Follow all instructions.
5. Do not use this apparatus near water.
6. Clean only with dry cloth.
7. Do not block any ventilation openings. Install in accordance with the manufacturer's instructions.
8. Do not install near any heat sources such as radiators, heat registers, stoves, or other apparatus (including amplifiers) that produce heat.
9. Do not defeat the safety purpose of the polarized or grounding-type plug. A polarized plug has two blades with one wider than the other. A grounding type plug has two blades and a third grounding prong. The wide blade or the third prong are provided for your safety. If the provided plug does not fit into your outlet, consult an electrician for replacement of the obsolete outlet.
10. Protect the power cord from being walked on or pinched particularly at plugs, convenience receptacles, and the point where they exit from the apparatus.
11. Only use attachments/accessories specified by the manufacturer.
12. Use only with the cart, stand, tripod, bracket, or table specified by the manufacturer, or sold with the apparatus. When a cart is used, use caution when moving the cart/apparatus combination to avoid injury from tip-over.
13. Unplug this apparatus during lightning storms or when unused for long periods of time.



14. Refer all servicing to qualified service personnel. Servicing is required when the apparatus has been damaged in any way, such as power-supply cord or plug is damaged, liquid has been spilled or objects have fallen into the apparatus, the apparatus has been exposed to rain or moisture, does not operate normally, or has been dropped.

Contents

Introduction	4-5
Front Panel	4
Connection Panel Overview	4
Remote Control Key Functions	5
Installation	6
Connections with TV and over-the-air antenna	6
Install Guide	6
Setup	7-11
Menu Overview	7
Typical Menu Operation	7
Setup Menu Features	7-8
Option Menu Features	8-9
Lock Menu Features	9-11
Operation	12-13
Channel Selection	12
Volume Adjustment	12
Signal	12
Auto Off	12
Channel Banner Display	12
Simple Guide	13
Program Information Display	13
Reference	14-15
Controlling Your TV with the Supplied Multi-brand Remote Control	14
Troubleshooting	15
Specifications	15

Manufactured under license from Dolby Laboratories. "Dolby" and the double-D are trademark of Dolby Laboratories.

Front Panel

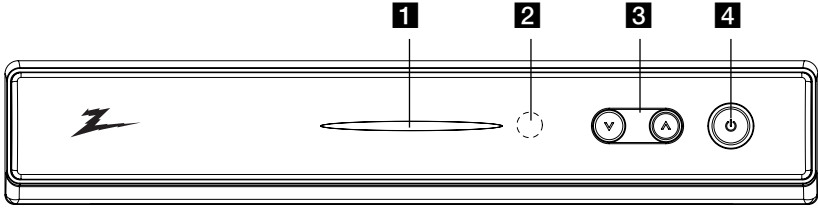

1 POWER indicator

Lights up red (standby mode) or blue (active mode). This indicator will blink when remote signal is received.

2 Remote Control Sensor

Receives signals from the Remote Control.

3 V/Δ (Channel Down/Up)

Scans up or down through memorized channels.

4 POWER

Turns the unit on or off.

Note

If you have a universal remote control, you may control this unit using it.

To program the remote control to control this unit, set the remote control's operation mode to TV or Settop Box, and set your remote control to the manufacturer codes of LG or Zenith.

Connection Panel Overview

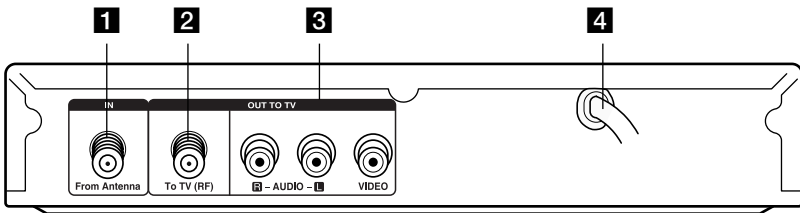

1 From Antenna

Connect to digital signal source; over-the-air antenna.

2 To TV (RF)

Connect to a TV with RF coaxial inputs.

3 VIDEO and AUDIO OUTPUT (Left/Right)

Connect to a TV/Monitor with Video and audio inputs.

4 AC Power Cord

Plug into the power source.

Remote Control

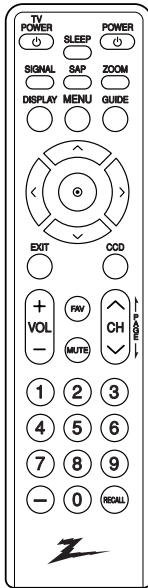

TV POWER

Turns the TV ON and OFF. (Refer to page 14)

SLEEP

Sets this unit to turn off automatically at a specified time. (Off → 1 hour → 2 hours → 3 hours → 4 hours)

POWER

Turns the UNIT ON and OFF.

SIGNAL

You can view the signal strength and listen to the beep sound according to signal strength for the current channel.

SAP

Selects program's audio language if available.

ZOOM

Changes the picture aspect ratio.

DISPLAY

Shows current program information for the current channel.

GUIDE

Brings up the Simple Guide.

CCD

Selects caption mode if available.

(Service 1-6 → CC 1-4 → Text 1-4 → Off)

MENU

Accesses or closes main menu.

EXIT

Removes all on-screen displays and returns to TV viewing from any menu.

Arrow Buttons (▲ / ▼ / ◀ / ▶)

Selects options in a menu.

⊙ (Select)

Selects highlighted menu function. Completes the channel number input and promptly tunes to selected channel.

FAV (Favorite)

Selects through the programmed Favorite channels.

MUTE

Turns sound ON and OFF.

CH (Channel) (▲ / ▼) / PAGE (↑/↓)

Selects channels in memory. Pages through the Channel Edit and Block Channel menu.

VOL (Volume) (+/-)

Sets sound level.

Numbers

Chooses channels and enters password.

- (Dash)

Enters a dash for sub channel numbers such as 2-1, 2-2, 47-3 etc.

RECALL

Returns to the last channel viewed.

Remote Control Operation

Point the remote control at the remote sensor and press the buttons.

Remote Control Battery Installation

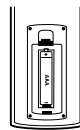

Detach the battery cover on the rear of the remote control, and insert a battery (size AAA) with ⊕ and ⊖ aligned correctly. We recommend to use the alkaline battery.

Connections with TV and over-the-air antenna

1. Connect the antenna to the “From Antenna” jack on this unit using a coaxial RF cable (**N**).
2. Connect the “To TV (RF)” jack on this unit to the “Antenna In” jack on your TV using a coaxial RF cable (**R**). Your TV must be tuned to the selected RF Output Channel (Refer to page 8) channel (3 or 4) to display the picture. (default: channel 3).

OR

Connect the VIDEO and AUDIO (L/R) jacks on this unit to the video and audio input jacks on the TV using the video (**V**) and audio (**A**) cable.

3. Plug the power cord into a power strip/surge protector or a wall outlet.

Notes

- Set “Audio Output” option to “Mono” if the unit is connected to TV with RF cable (See page 9).
- “To TV (RF)” jack passes the analog signal from the “From Antenna” jack to your TV/monitor if the unit is turned off.

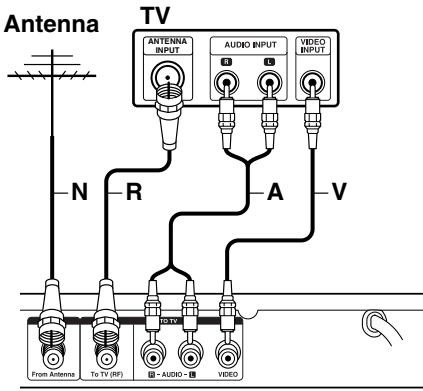

Rear of this unit

Install Guide

The Install Guide is a convenient way for you to customize the settings of this unit. When the unit is turned on for the first time after connecting the power supply, Install Guide is displayed on the screen automatically.

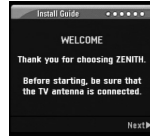

Step 1 (Welcome Message)

Press > to move to the next step.

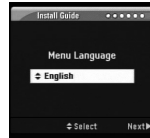

Step 2 (Menu Language)

Use ^ / v to select a language (English, Spanish, French) then press > to move to the next step.



Step 3 (TV Aspect Ratio)

Use ^ / v to select your TV type then press > to move to the next step.



Step 4 (Searching for Channels...)

Press (Select) to start auto tuning. After auto tuning is complete, press > to move to the next step.

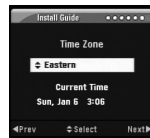

Step 5 (Time Zone)

Use ^ / v to select a time zone then press > to move to the next step.



Step 6 (Thank You Message)

Press (Select) to finish install guide.

Menu Overview

By using the menu, you can make various adjustments to menu options such as picture and sound.

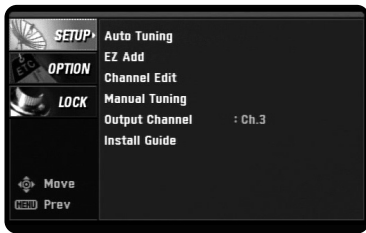

Note

A password is required to gain access to Auto Tuning and Manual Tuning menu if the Lock System option is set to "On" (See page 10).

To display and exit the Menu:

Press MENU to display the menu. A second press of Menu will take you back to initial screen.

To go to the next level:

Press > on the remote control.

To go back to the previous level:

Press < on the remote control.

Typical Menu Operation

1. Press MENU. The menu appears.
2. Use V / ^ to select the desired option then press > or (Select) to move to the second level.
3. Use ^ / V to select the second desired option then press > to move to the third level.
4. Use ^ / V to select the desired setting then press (Select) to confirm your selection. Some items require additional steps.
5. Press EXIT to exit the menu.

Setup Menu Features

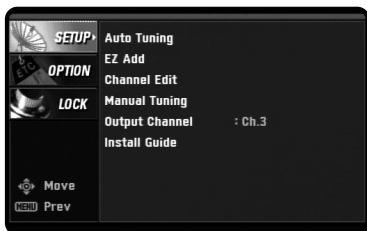

Auto Tuning

Automatically finds all digital channels available through the 'Antenna In' source and stores all the active channels found. Select "Auto Tuning" option then press (Select) to start auto tuning.

EZ Add

Automatically adds new channels available through the antenna input to the memorized channels already in the channel list. Select "EZ Add" option then press (Select) to start auto tuning.

Channel Edit

Channel Edit allows you to manually add or delete channels from the channel list in memory.

1. Select "Channel Edit" option then press (Select) or >. The Channel Edit menu appears.
2. Select a channel on the Channel Edit menu.
3. Press (Select) to add or delete the channel.

or

Press FAV to add the channel to the Favorite Ch. list.

Note

Deleted channels can not be selected with the CH (V/^) buttons.

Tip

While watching TV, you can select a favorite channel using FAV button on the Remote Control.

Setup Menu Features (Continued)

Manual Tuning

This feature manually adds or deletes channels.

1. Select “Manual Tuning” option then press **⊙** (Select) or **>**.
2. Select a channel to add or delete.
3. Press **⊙** (Select) to confirm your selection.
4. Repeat steps 2-3 to add or delete additional channels.

Output Channel

If you use the To TV (RF) jack, select channel 3 or 4 to send RF signal from the unit to your TV. Your TV must be tuned to the selected channel to display the picture.

Install Guide

The Install Guide is a convenient way for you to customize the settings of this unit. Select [Install Guide] option then press **⊙** (Select) and Install Guide menu will appear, see page 6.

Option Menu Features



Clock

Enables the user to set up the clock information. Normally, your clock is set using signals transmitted by DTV stations. Choosing your time zone sets the current time automatically.

1. Select “Clock” option then press **⊙** (Select) or **>**.

2. Use **<** or **>** to select your time zone then press **V** to move to “Day Light Saving” option.
3. Use **<** or **>** to select a “Day Light Saving” option.
You can turn Day Light Saving “On” or “Off” manually. If it is set to “Auto”, the unit will use the clock information from DTV stations to determine the proper setting.
4. Press **⊙** (Select) to confirm your setting.

Note

In the case when a TV station does not send, or sends wrong data and/or information, the unit may be set to an incorrect time.

TV Aspect Ratio

Select your TV type.

- 4:3 – Select when a standard 4:3 TV is connected.
- 16:9 – Select when a 16:9 wide TV is connected.

Aspect Ratio

Selects the screen format for current channel. The options displayed differ depending on the TV Aspect Ratio.

Note

The changed aspect ratio is applied only to current channel.

Tip

While watching TV, you can change the aspect ratio using ZOOM button on the Remote Control.

Language

Select a language for the audio and menu. (English, Spanish, or French)

Option Menu Features (Continued)

Caption

Allows you to select an option for displaying Caption Data from the unit.

Mode – Select “Analog” or “Digital” to use the analog or digital caption feature. If not, select “Off”.

Analog – Selects a mode for displaying Analog Caption Data. In the Analog Caption Service, CC 1-4 display program’s dialog, and Text 1-4 display data service information.

Digital – Selects a mode for displaying Digital Caption Data (Service 1-6).

Digital Option – Selects Digital Caption appearance menu options.

Style: Use caption feature defaults as provided by the program or customize caption appearance with the Custom menu options.

Size: Selects the font size.

Font: Selects the font type.

Text Color: Selects the font color.

Text Opacity: Selects the font opacity.

Bg. (Background) Color: Selects the background color.

Bg. (Background) Opacity: Selects the background opacity.

Edge Type: Selects the edge type.

Edge Color: Selects the edge color.

Tip

While watching TV, you can change the caption option using CCD button on the Remote Control.

Auto Off

Sets a time the TV will turn off.

If you do not press any button within the preset time, this feature automatically turns the unit off. (Default: 4 hours)

If you select “Off”, Auto Off is not active.

Tip

you can select a time for the Auto Off using SLEEP button on the Remote Control.

Audio Output

Select the appropriate audio output mode of the unit depending on your TV connection.

Stereo – When your TV is connected with stereo audio cable (L/R).

Mono – When your TV is connected with mono audio cable or RF cable.

Lock Menu Features

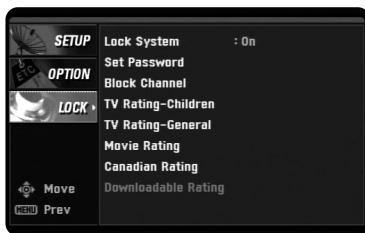

Tip

To access the LOCK menu, you must input the 4-digit password. (The default password is “0000”.)

Lock System

Allows you to set up specific channels and ratings through blocking schemes. Also allows you to activate or disable all of the lock schemes previously set up. A password is required to gain access to the LOCK menus.

If the Lock System is set to Off, the Channel and Program Ratings are not functional.

Set Password

Changes the password.

1. Select the “Set Password” option then press **⊙** (Select) or **>**.
2. Enter the new 4-digit password.
3. Enter the same password again for new password’s confirm.

Block Channel

Blocks any channel that you do not want to view or that you do not want your children to watch. If you tune in a blocked channel, a black screen with a pop-up box will appear.

1. Select “Block Channel” option then press **⊙** (Select) or **>**.
2. Select a channel then press **⊙** (Select) to block or unblock the channel. The **🔒** mark will appear to the right of the station name to indicate the blocked channel.
3. Repeat step 2 to block or unblock additional channels on the channel list menu.

TV Rating-Children

Prevents children from watching certain children’s TV programs according to the ratings limit set. This rating applies only to TV programs for children. Unless you block TV programs intended for mature audiences in the TV Rating – General menu, your children could view those programs.

1. Select the “TV Rating-Children” option then press **⊙** (Select) or **>**.
2. Select the “Age” or “Fantasy Violence” option then press **⊙** (Select) or **>**.
Age: Selection applies regardless of content category of rating.
Fantasy Violence: Selection applies if TV programs include rating for Fantasy Violence.
3. Select a rating then press **⊙** (Select).
TV-Y: All Children.
TV-Y7: Directed toward children age 7 and older.

TV Rating-General

Blocks TV programs that you or your family may not wish to watch, based on the rating scheme set.

1. Select the “TV Rating-General” option then press **⊙** (Select) or **>**.

2. Select the “Age”, “Dialogue”, “Language”, “Sex”, or “Violence” option then press **⊙** (Select) or **>**.
Age: Selection applies regardless of content category of rating.
Dialogue: Selection applies if TV programs have rating for Dialogue.
Language: Selection applies if TV programs have rating for Language.
Sex: Selection applies if TV programs have rating for Sex.
Violence: Selection applies if TV programs have rating for Violence.
3. Select a rating then press **⊙** (Select).
TV-G: General Audience.
TV-PG: Parental Guidance Suggested.
TV-14: Parents Strongly Cautioned.
TV-MA: Mature Audience Only.

Movie Rating

Blocks movies according to the movie ratings restrictions so children cannot view certain movies. You can set the ratings to block out all the movies with ratings above a specified level. Keep in mind that the movie ratings apply only to movies shown on TV, not TV programs such as soap operas.

1. Select the “Movie Rating” option then press **⊙** (Select) or **>**.
2. Select a rating then press **⊙** (Select).
G: General Audiences
All ages admitted.
PG: Parental Guidance Suggested.
Some material may not be suitable for children.
PG-13: Parents Strongly Cautioned
Some material may not be appropriate for children under 13.
R: Restricted Under 17 requires accompanying parent or adult guardian.
NC-17: No one 17 and under admitted.
X: No one 17 and under admitted.

Canadian Rating

Blocks Canadian TV program that you or your family may not wish to watch, based on the Canadian English/French Language Rating system.

1. Select the “Canadian Rating” option then press **⊙** (Select) or **>**.
2. Select the “English” or “French” option then press **⊙** (Select) or **>**.
3. Select a rating then press **⊙** (Select).

English: Selection applies if TV programs have the Canadian English Language Rating.

French: Selection applies if TV programs have the Canadian French Language Rating.

For Canadian English Language Rating system

C: Program intended for children under age 8.

C8+: Program generally considered acceptable for children 8 years and over to watch on their own.

G: General audience.

PG: Parental guidance.

14+: Program contains themes or content which may not be suitable for viewers under the age of 14.

18+: Adult program.

For Canadian French Language Rating system

G: General - Program intended for audience of all ages.

8 ans+: Not recommended for young children.

13 ans+: Program may not be suitable for children under the age of 13.

16 ans+: Program is not suitable for children under the age of 16.

18 ans+: Program restricted to adults.

Downloadable Rating

The rating information can be updated if the TV station sends the downloadable rating information.

1. Select the “Downloadable Rating” option then press **⊙** (Select) or **>**.
2. Select a rating title or TV rating then press **⊙** (Select) or **>**.
3. Select a rating then press **⊙** (Select).

Note

- If information is not downloaded from the TV station, the Downloadable Rating option is not available.
- Rating information is automatically downloaded while watching DTV channels. It may take several seconds.
- The Downloadable Rating option is available for use after rating information is downloaded from the TV station. However, depending on the information from the TV station, it may not be available for use.
- Rating levels differ depending on the broadcasting station.
- The default option name and Downloadable Rating changes depending on the downloaded information.
- The on-screen display for Downloadable Rating options will appear with a language that TV station sends.
- The rating titles (For example: Humor, etc) and TV ratings (For example: MH, H, VH, etc) may differ depending on the TV station.

Channel Selection

You can select channels as described below.

- Use Number (0-9) and – (dash) buttons to select a channel directly.
- Press FAV to scroll through your favorite channels.
- Press RECALL to return to the previous channel you viewed.
- Use CH ∇/\wedge on the Remote Control or ∇/\wedge on the front panel to select a channel through the channels in memory.

Tip



If you press any number button for channel selection, Channel List will appear and you can select a channel easily on the list.

Volume Adjustment

Adjusts the sound level for audio out on the unit.

- Use VOL +/- to adjust the sound level for audio out on the unit.
- Press MUTE to turn off the volume for audio out on the unit.

Caution

Removing the MUTE function may cause hearing or speaker damage if the TV volume is set too high.

Signal

You can view the signal strength bar to help you adjust the antenna to the correct direction for your location by pressing SIGNAL on the Remote Control. An audible beep accompanies the signal strength bar.

Tip

Refer to www.antennaweb.org for antenna information for your receiving location. AntennaWeb.org, will help you determine the proper outdoor antenna to use in order to receive television channels that are broadcast locally.

Auto Off

This unit will be automatically turned off, in case of no button input for a preset time. You can set a time using the SLEEP button.

If you select “Off”, Auto Off is not activated.

Note

The confirm message will appear before 1 minute from Auto Off time.

Channel Banner Display

The Channel Banner shows channel number, station name, current time, and block information for a moment.



The Channel Banner appears whenever you tune to a new channel or press the \odot (Select) button while viewing a program.

Press \odot (Select) to clear Channel Banner from being displayed.

Note

- Station name and clock are displayed only if they are provided by broadcaster.
- Block Information displays such as No Signal, Rating Blocked, or Channel Blocked.

Simple Guide

Use the Simple Guide to see the information for a current or next program easily and conveniently.



To display or exit the Simple Guide

Press the GUIDE button on your remote control.

To view other channel's information

Use < / > on your remote control to navigate the Simple Guide screen.

To tune to another channel

Use < / > on your remote control then press  (Select).

Note



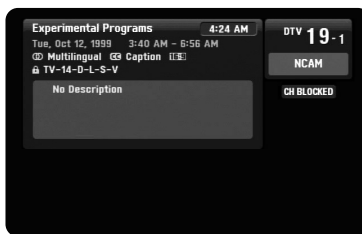

The channel information in Simple Guide menu are displayed only if they are provided by broadcaster, and the information for each channel can be received only if the unit is tuned to the channel.

Program Information Display

The Information Display appears if you press the DISPLAY button on the remote control while viewing a program.



The Program Information shows items listed below.

- Program Title
- Current date
- Start and End Time
- Current time
- Channel Number
- Station Name
- Multilingual Icon ()
Indicates that multiple audio tracks are available. You can select an alternate audio language track with SAP button.
- Aspect Ratio Icon (, )
Indicates that the current program is transmitted in wide or 4:3 picture format. Press ZOOM to view letterbox or cropped as desired.
- Closed Caption Icon ()
Indicates that the current program contains Caption Data Service.
- Content Advisory Icon ()
Indicates that the current program contains content advisory data, and displays rating value of program.
- Program Details
A description of the program may be available from the broadcaster

Controlling Your TV with the Supplied Multi-brand Remote Control

You can control the power switch of your TV with the supplied Multi-brand Remote Control. If your TV is listed in the table, set the appropriate manufacturer code.

To program the Remote Control to control your TV

1. While pressing and holding down the TV POWER button, press the CH \wedge or CH \vee repeatedly until your TV is turned on or off.
 - Each press of CH \wedge or CH \vee button sends a manufacturer code (1 - 45) to your TV one after the other.
2. Release TV POWER button when your TV is turned on or off.

Note

- Depending on your TV, TV POWER button may not function on the TV.
- When you replace the batteries of the remote, the remote control may be reset to the default setting. Program it to control again.

Controllable TV Brands

Manufacturer
Abex
Admiral
Advent
Aiko
Akai
America Action
Anam
Anam National
AOC
Apex Digital
Audiovox
Baysonic
Bell&Howell
Bradford
Broksonic

Manufacturer
Candle
Carnivale
Carver
Celebrity
Celera
Changhong
Citizen
Clarion
Contec
Craig
Crosley
Crown
Curtis Mathes
CXC
Daewoo

Manufacturer
Durabrand
Electroband
Elektra
Emerson
Envision
Fisher
Funai
Futuretech
GE
Gibraltar
GoldStar
Grunpy
Haier
Hallmark
Harley Davidson
Harman/Kardon
Harvard
Havermy
Hello Kitty
Himitsy
Hisense
Hitachi
Infinity
Insignia
JBL
JCB
Jensen
JVC
KEC
Kenwood
KLH
KTV
LG
Lloyd's
LXI
Magnasonic
Magnavox
Magnin
Marantz
Masushita
Megatron
Memorex
MGA
Midland
Mitsubishi
Motorola
MTC
Multitech
NAD
NEC
Nikko
Norcent
NTC
Onwa
Optimus

Manufacturer
Orion
Panasonic
Penney
Philco
Philips
Pilot
Poptonica
Portland
Prima
Prism
Proscan
Proton
Quasar
RadioShack
RCA
Realistic
Runco
Sampo
Samsung
Samsux
Sansui
Sanyo
Scotch
Scott
Sears
Sharp
Sheng Chia
Simpson
Sony
Soundesign
Squareview
SSS
Starlite
Supreme
SVA
Sylvania
Symphonic
Tandy
Tatung
Technics
Techwood
Teknika
Thomas
TMK
Toshiba
Totevision
TVS
Vector Research
Victor
Vidikron
Vidtech
Wards
White Westinghouse
Yamaha
Zenith

Troubleshooting

No power.

- Plug the power cord into the wall outlet securely.

Fragmented picture and unclear sound.

- Check your antenna input, location, and signal strength.

No picture.

- Select the Auto Tuning or Manual Scan functions if you have not already done so.
- Check to make sure all the cables are installed correctly and that the proper source is selected on your TV. For example, CH 3, CH 4, Video 1 or Video 2.
- The antenna signal strength may be low. Check the signal strength and adjust the antenna location and direction.
- For more information about connections, please refer to connections on page 6.

Normal picture but no sound.

- Check volume levels.
- Make sure the TV is not muted.
- Check that the unit is connected properly.

Picture is distorted.

- Make sure the proper aspect ratio is selected.
- Make sure the video output is connected to the TV.

Available channels are missing.

- You can find all the available channels by running the “Auto Tuning” or “EZ Add” in the SETUP menu.

You forgot your password.

- Enter the master password “7777”.

The Remote Control does not work properly.

- Point the Remote Control at the remote sensor on the unit.
- Operate the Remote Control within 23 ft (7 m).
- Remove any obstacles blocking the signal.
- Replace dead batteries with new ones.

Specifications

General

- Television System: DTV standard ATSC
- Channel Coverage: Terrestrial 2-69
- Dimensions (W x H x D):
Approx. 8.5 x 1.8 x 6.4 inches
(215 x 46 x 162 mm)
- Net Weight): Approx. 1.65 lbs (0.75 kg)
- Operating temperature:
41 °F to 104 °F (5 °C to 40 °C)
- Operating humidity: 5 % to 90 %
- Power requirement: 120V ~ 60 Hz AC.
- Power consumption: 7 W

Input/Output

- From Antenna:
Antenna input, ATSC, 75 Ω
- To TV (RF):
Antenna output, 75 Ω ,
RF Output Channel 3 or 4 (Switchable)
- VIDEO OUTPUT:
1.0 V (p-p), 75 Ω , negative sync,
RCA jack x 1
- AUDIO OUTPUT:
2.0 Vrms (1 KHz, 0 dB), 600 Ω ,
RCA jack (L, R) x 1

Accessories

- RF cable (1)
- Video cable (1)
- Audio (L/R) cable (1)
- Remote Control (1)
- Battery (size AAA) (1)
- Owner’s Manual (1)

Note

Design and specifications are subject to change without prior notice.

ANALOG PASS-THROUGH FEATURE

Federal law requires that all “full-power” television stations must end analog broadcasts after February 17, 2009, but this does not include “low-power” TV stations (such as “low-power” or “community” stations of very restricted range (LPTV), “Class A” stations, and “translator” or “booster” stations).

These stations may continue to broadcast in analog after the February 17, 2009, digital conversion deadline for full-power television stations.

This converter box has a feature called “Analog Pass-Through,” which allows your analog TV to continue to tune the analog low-power stations. Simply put, to receive analog stations, turn off the box; the analog signal will “pass-through” the box to be tuned in the TV. To enjoy the digital stations, tune them through the converter box as explained in this operating guide.

NOTE: Online resources with low-power TV information include: www.dtvtransition.org/lowpower, <https://www.dtv2009.gov/lowpower/>, and www.dtv.gov. For a map and list of low-power stations by state, please visit www.ntia.doc.gov/dtvcoupon/LPTVmap.html

FCC DIGITAL TV TRANSITION NOTICE

This device contains a digital television tuner so it can receive free, over-the-air DTV broadcasts. After February 17, 2009, a television receiver with only an analog broadcast tuner will require a converter box to receive full-power over-the-air broadcasts with an antenna because of the Nation’s transition to digital broadcasting. Analog-only TVs should continue to work as before to receive analog low-power, Class A or translator television stations and with cable and satellite TV services, gaming consoles, VCRs, DVD players and similar products. Information about the DTV transition is available at www.DTV.gov or from this manufacturer at 1-877-993-6484.

For information about the government’s digital-to-analog converter box coupon program, contact www.dtv2009.gov or call 1-888-DTV-2009.



Zenith Electronics LLC Limited Warranty - USA

This Zenith Electronics product, will be repaired or replaced, at Zenith's option, if it proves to be defective in material or workmanship, under normal use, during the warranty period ("Warranty Period") listed below, effective from the date ("Date of Purchase") of original consumer purchase of the product. This warranty is good only to the original purchaser of the product and effective only when used in the United States, excluding U.S. Territories.

WARRANTY PERIOD: LABOR: 90 days from the Date of Purchase. PARTS: One Year from the Date of Purchase. * Parts replaced are warranted for the remaining portion of the original warranty period.	HOW SERVICE IS HANDLED: Call 1-877-9-ZENITH for instructions on getting the defective unit repaired or replaced. Please retain dated sales receipt and your box to return the unit to Zenith for repair or replacement. Shipping both ways will be paid by Zenith during the first 90 days of the Warranty Period. During the remainder of the Warranty Period (91 ~365 days), you pay inbound shipping charges and Zenith pays return shipping charges. Visit our website at: http://www.zenithservice.com
---	---

THIS WARRANTY IS IN LIEU OF ANY OTHER WARRANTIES, EXPRESS OR IMPLIED, INCLUDING WITHOUT LIMITATION, ANY WARRANTY OF MERCHANTABILITY OR FITNESS FOR A PARTICULAR PURPOSE. TO THE EXTENT ANY IMPLIED WARRANTY IS REQUIRED BY LAW, IT IS LIMITED IN DURATION TO THE EXPRESS WARRANTY PERIOD ABOVE. ZENITH ELECTRONICS WILL NOT BE LIABLE FOR ANY INCIDENTAL, CONSEQUENTIAL, INDIRECT, SPECIAL OR PUNITIVE DAMAGES OF ANY NATURE, EVEN IF ADVISED OF THE POSSIBILITY OF SUCH DAMAGES, INCLUDING WITHOUT LIMITATION, LOST REVENUES OR PROFITS, LOST OR CORRUPTED PROGRAMMING OR DATA, OR ANY OTHER DAMAGE WHETHER BASED IN CONTRACT, TORT OR OTHERWISE. Some states do not allow the exclusion or limitation of incidental or consequential damages or limitation on how long an implied warranty lasts, so the above exclusion or limitation may not apply to you. This warranty gives you specific legal rights and you may also have other rights that may vary from state to state.

THIS LIMITED WARRANTY DOES NOT APPLY TO:

- Damages or operating problems that result from shipping, installation, adjustment of user controls, calibration, maintenance or failure to maintain, or separate system components; and
- Damages or operating problems that result from normal wear and tear, misuse, abuse, operation outside environmental specifications or contrary to the requirements or precautions in the Operating Guide, accident, lightning strikes or other natural causes, unauthorized modification or alteration, incorrect electrical current or voltage, signal reception or input, software not licensed directly by Zenith, software errors that do not disable functionality, operating and software protocols adopted after the date of manufacture or for outside the US, institutional or commercial use, or other causes not arising out of defect in material or workmanship.

The cost of repair or replacement under these excluded circumstances shall be borne by the consumer.

CUSTOMER INTER-ACTIVE CENTER NUMBERS:

For Warranty Service, Where to buy, Product Assistance, or Customer Assistance	Call 1-877-9-ZENITH (24 hours a day, 365 days per year) and select appropriate options from the menu. Or visit our website at http://www.zenithservice.com
---	---

LG ELECTRONICS U.S.A., INC.
1000 SYLVAN AVENUE
ENGLEWOOD CLIFFS, NJ

P/N: MFL38574941
Printed in China
Issue O